

NOT to scale

Assembled Game

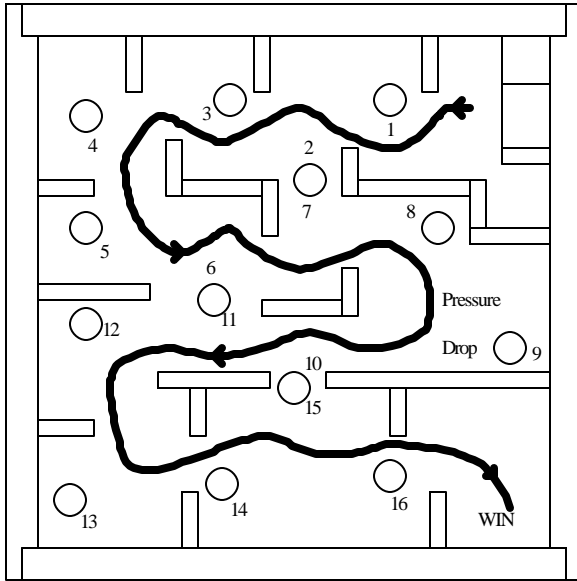

Sides A

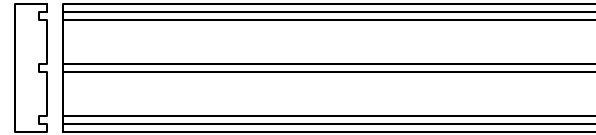

Sides B

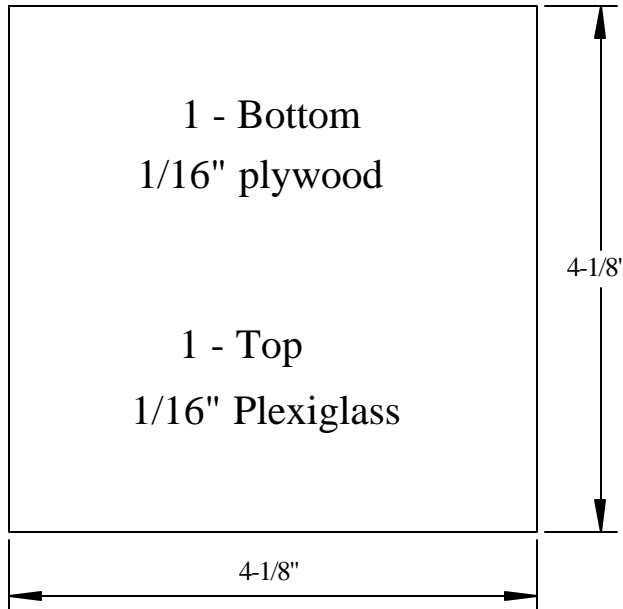
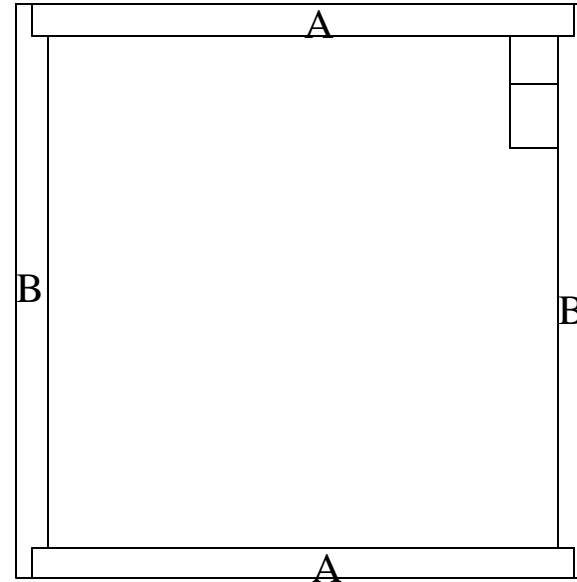
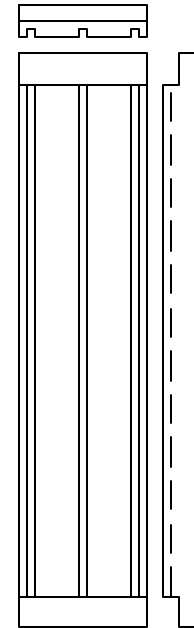

Game Surface

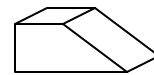
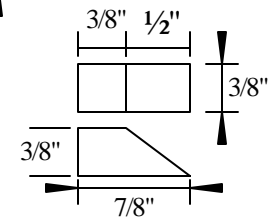
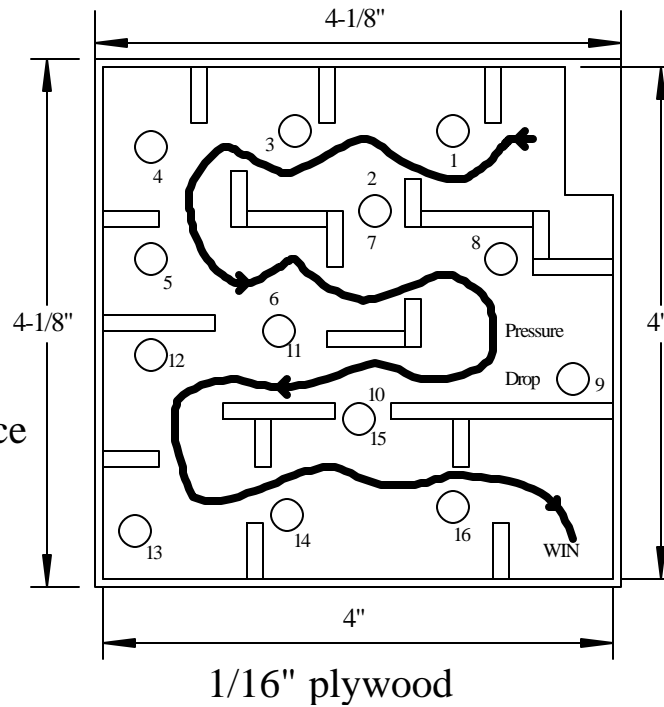

Ball Ramp

# Game Surface Layout

Full Scale 1" = 1"

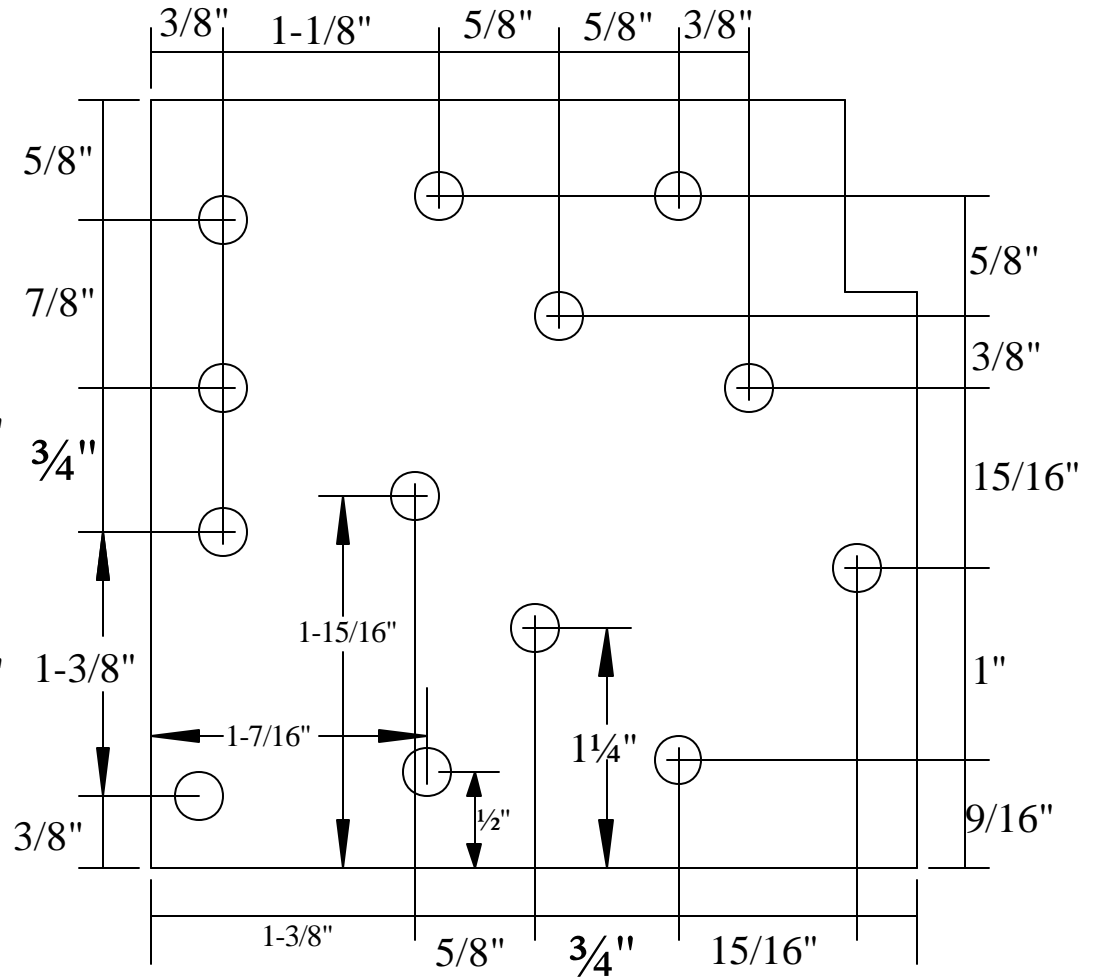
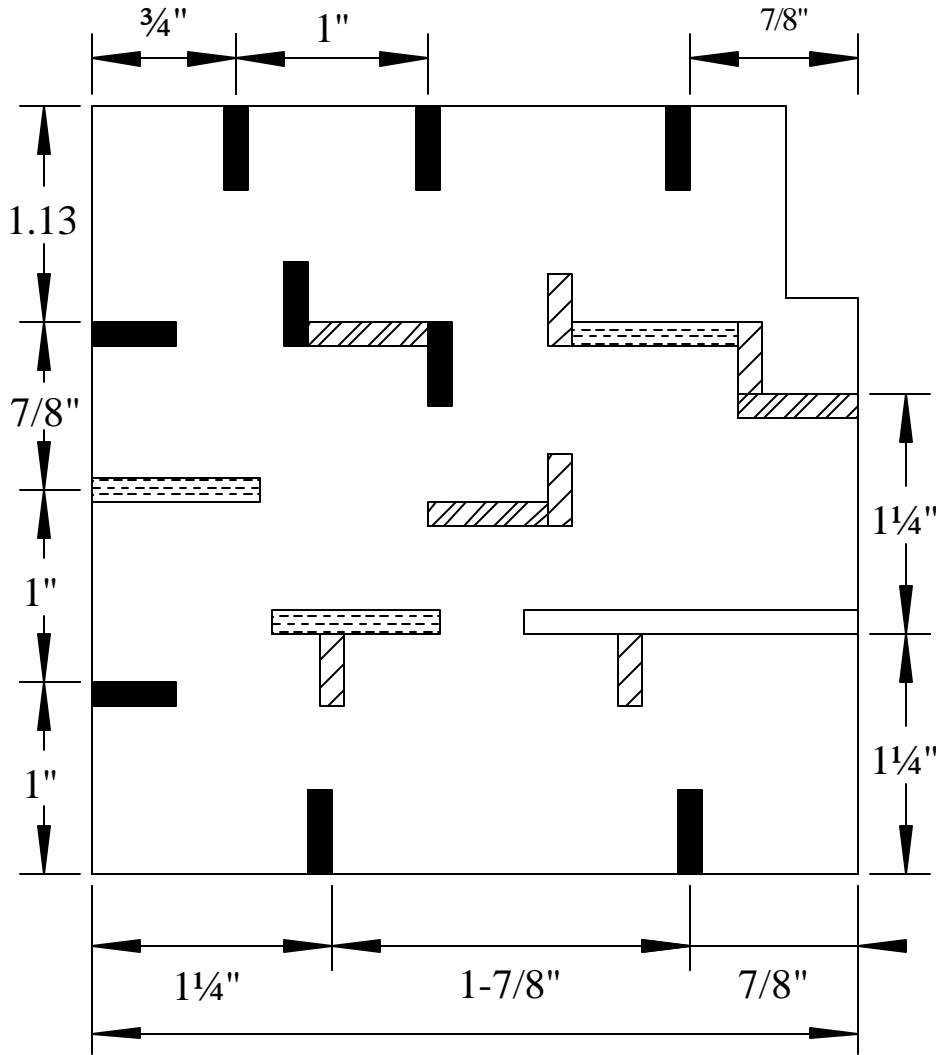

All Holes - 1/4" diameter

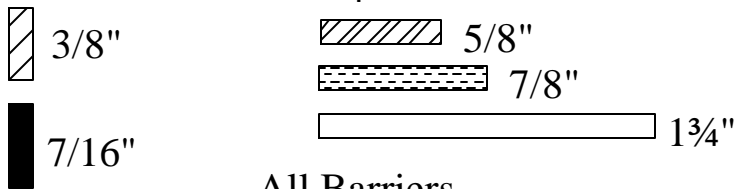

All Barriers -  
1/8" wide by 5/16" tall